

— FVA Troglux short version variable area flowmeter —

Operating Instructions

All rights reserved. It is prohibited to reproduce this document, or any parts thereof, without prior written authorization of MECON Flow Control Systems GmbH.

Subject to change without notice.

Copyright 2013 by

MECON Flow Control Systems GmbH - Röntgenstraße 105 - 50169 Kerpen

Contents

1 Safety Instructions	4
1.1 Intended use	4
1.2 Certifications	5
1.3 Safety instructions from the manufacturer	5
2 Start-up	6
2.1 Standard device	6
3 Installation	7
3.1 Installation instructions	7
3.2 Installation	7
4 Service	8
4.1 Storage	8
4.2 Maintenance	8
4.3 Returning the device to the manufacturer	8
5 Device Description	9
5.1 Scope of delivery	9
5.2 Versions	9
5.3 Name plate	10
6 Description Code	11
7 Measuring range for liquids	13
8 Measuring range for air	14
9 Technical Data	15
9.1 Pressure and temperature limits	15
9.2 Dimensions	16
10 Contacts	17

1 Safety Instructions

1.1 Intended use

The FVA Troglux short version variable area meters are used to measure the volume of transparent liquids and gases passing through closed piping. The variable area meters can also be used for flow monitoring if they are equipped with one or more switching contacts. Standard scales are available for liquids with a density of 1 kg/l (62.43 lb/cu.ft). The scales must be recalculated for all other media depending on the physical characteristics.

The devices are particularly suitable for the measurement of:

- Water
- clear liquids
- gas flows



Warning !

The operator of these measuring devices is solely responsible for the suitability, intended use and corrosion resistance of the selected materials. It must be particularly ensured that the materials selected for the wetted parts of the flowmeter are suitable for the process media to be measured.

The manufacturer is not liable for any damage resulting from improper or unintended use of these devices.

No external loads may act on the meter. The flowmeters are primarily designed for static applications.



Caution!

Hot surfaces resulting from hot process media.

Danger of burns resulting from surface temperatures above 70 °C.

Take appropriate protective measures, for example contact protection.

The design of the contact protection must meet the maximum permissible ambient temperature of the meter.

The flowmeter may only be operated within the pressure and voltage limits specified on the name plate.

Before taking the flowmeter out of operations, check that the unit is free of hazardous media and de-pressurized.

1.2 Certifications

CE marking



The manufacturer certifies for the device FVA Troglux short version meets all statutory requirements of the following EC directives by applying the CE marking:

- Pressure equipment directive 97/23/EC

The most hazardous permissible media are

- **for gases: fluids of group 2**
- **for liquids: fluids of group 1.**

1.3 Safety instructions from the manufacturer

Disclaimer

The manufacturer will not be liable for any damage resulting from the use of its product, including, but not limited to direct, indirect, incidental, punitive and consequential damages.

Any product purchased from the manufacturer is warranted in accordance with the relevant product documentation and our Terms and Conditions of Sale.

The manufacturer reserves the right to revise the content of its documents, including this disclaimer, without prior notification, and will not be liable in any way for possible consequences of such changes.

Product liability and warranty

Mecon GmbH assumes no guarantee for repair work carried out by the customer without prior notification and consultation. Any instruments or parts rejected by a customer must be returned to us, if no other arrangement has been made.

General information

This manual is intended for the correct installation as well as operation and maintenance of the devices. Read the instructions carefully before installing the device and placing it into operation.

Specially designed or customised models and specialised applications are not included in this manual.

2 Start-up

2.1 Standard device

When starting up the unit, the following points must be observed:

- Make sure that the actual operating conditions (pressure and temperature) do not exceed the limits specified on the nameplate.
- **Avoid float float impact!**
Therefore it is recommended to start with a closed shut-off valve during commissioning and adjust the operating pressure by opening the valve slowly.
In particular, the use of magnetic valves is not recommended in this case.
- When measuring liquids, make a careful release of the pipeline to prevent water hammer by gas bubbles.
- When commissioning new devices increasingly residues can stick on the float. Therefore we recommend to clean the equipment after a relatively short time.
- When using the devices in the lower measuring range the device must be operated at a higher flow rate for a short time to enable settling of the float.

Exceptions for the measurements of gases:

- Provide valves downstream the flowmeter if $p_{abs} > 1,013$ bar and usually upstream the flowmeter if $p_{abs} = 1,013$ bar (no overpressure).
- Install a flow control valve close to the flowmeter (downstream), to prevent oscillations during the measurement.
- Adjust the operating pressure exactly to the reference pressure (during calibration) to prevent measurement errors.

3 Installation

3.1 Installation instructions

**Information!**

All instruments are carefully checked for proper function before shipment. Check immediately on receipt, the outer packing carefully for damage or signs of improper handling.

Report damage to the carrier and your competent sales staff. In such cases, a description of the defect, the type and the serial number of the device is indicated.

**Information!**

Unpack the unit carefully to avoid damage.

**Information!**

Check the completeness of the delivery against the packing list. Check the name plate, if the delivered flow meter according to your order. Check whether particular units with electrical components have the correct supply voltage printed.

3.2 Installation

For specific device sizes the float is inserted with a plastic net for transport lock. This must be removed before installation through the top of the meter. After that the free movement of the float inside the flow tube should be checked again.

The device must be mounted vertically and stress-free. Reductions, extensions, and control elements upstream and downstream of the meter have no influence on the measurement accuracy with liquids. For gases, however, the installation of the meter is recommended before valves to prevent compression oscillations.

Since variable area flow meters are very sensitive to changes in flow, control elements should always be adjusted slowly. The calibration is carried out for a defined use. Deviations of the density, pressure or temperature of gases, as well as density and viscosity of liquids, result in errors. It is essential to ensure compliance with the calibration conditions. Therefore it is essential to specify the following data of the medium in the order: the medium, the density and the viscosity at operating temperature and pressure. For gases, the exact reference point for the pressure (gauge or absolute pressure) is also required. Retrofitting of switching contacts is only possible when the floats are used with magnets. At the first start the float must be moved all over the contact for polarization.

4 Service

4.1 Storage

Store the device dry and dust free.

Avoid direct exposure to the sun and heat.

Avoid external loads on the device.

The admissible storage temperature for standard devices with electrical components: -40 ... +70 °C.

4.2 Maintenance

The devices are built for low maintenance operations but periodically the flowmeters should be inspected for signs of corrosion, mechanical wear as well as damage to the fitting and the display unit.

We advise to carry out inspections at least once a year.

For a detailed inspection and cleaning the device must be removed from the piping.



Caution !

*Appropriate safety precautions have to be taken when removing the device.
Always use new gaskets when reinstalling the device in the piping..*

4.3 Returning the device to the manufacturer

This device has been carefully manufactured and tested.

Should you nevertheless need to return a device to MECON GmbH please observe the following points:



Caution !

According to the actual waste disposal directives, the owner/customer is responsible for the waste management of hazardous and toxic waste.

*For reasons of environmental protection and safeguarding the health and safety of our personnel **all devices sent to MECON GmbH to be repaired must be free of toxic and hazardous substances. This also applies to cavities of the devices. If necessary the customer is kindly requested to neutralize or rinse the devices before returning them to MECON.***

The customer has to confirm this by filling in an appropriate form which is available for download on the MECON website:

www.meccon.de/en/declaration/contamination.pdf



Caution !

In case of returning devices which contain hazardous and toxic substances MECON GmbH is entitled to dispose of these substances at cost to the customer without any further notices

5 Device description

5.1 Scope of delivery



Fig. 1 Scope of delivery



Information !

Please check the delivery for completeness using the packing list.

5.2 Versions



Fig. 2 Standard device with PVC adhesive bushing

The flowmeters FVA Troglux short version exists in their main components from the plastic measuring tube with float and the connecting parts. The displayed directly on the scale on the flow tube (eg in l / h). A scale is printed on the flow tube (eg in l / h). The actual flowrate is read at the position of the largest diameter of the float. For process monitoring and control, the unit can be equipped with one or more contacts.

Special features

- Product scales for liquids and gases
- Easy to install
- Low cost plastic version
- Short delivery times for standard versions

5.3 Nameplate



Important !

Please refer to the device nameplate to ensure that the device is built according to your order.

Check particularly for the correct supply voltage.

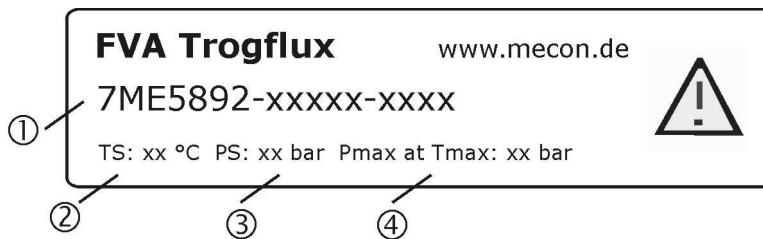

Fig. 3 Nameplate FVA Troglux

- | | |
|--|--|
| ① Code number | Device specific code number |
| ② TS Medium | Maximum temperature of the medium |
| ③ PS | Maximum pressure of the medium |
| ④ P _{max} at T _{max} | Maximum pressure of the medium at temperature T _{max} |

6 Description Code

The description code consists of the following elements:

7ME5892 - / ...

①
②
③
④
⑤
⑥
⑦
⑧
⑨

① Gasket material

- 1** Perbunan
- 4** Viton
- 8** EPDM

② Measuring cone size

- AC** 40
- BC** 65
- CC** 100
- DC** 160
- EC** 250
- FD** 400
- GD** 650
- HD** 1000
- JD** 1600

③ Float material

- 1** Stainless steel (1.4301)
- 2** Stainless steel (1.4571/1.4404)
- 3** PVC, weighted
- 5** Aluminium
- 6** PVC, not weighted

④ Connection material

- 1** PVC
- 2** Cast iron (only for G½, G1)
- 3** Steel (not for G½, G1)
- 4** Stainless steel

⑤ Connection form

- 1** Adhesive bushing (only in PVC)
- 2** Female thread DIN ISO 228
- 3** Female thread NPT (NPT ANSI B1.20.1)

⑥ Connection size

- A** Adhesive bushing
- B** Female thread G $\frac{1}{4}$ / NPT $\frac{1}{4}$ "
- C** Female thread G $\frac{3}{8}$ / NPT $\frac{3}{8}$ "
- D** Female thread G $\frac{1}{2}$ / NPT $\frac{1}{2}$ "
- E** Female thread G $\frac{3}{4}$ / NPT $\frac{3}{4}$ "
- F** Female thread G1 / NPT1"

⑦ Contacts (only with magnetic floats)

- A** Without contact
- C** Contact K18/A (closes when below the limit)
- D** Contact K18/B (closes when exceeding the limit)
- E** 2 Contacts K18/A
- F** 2 Contacts K18/B
- G** One of each contact K18/A and K18/B

⑧ Float version

- 0** Standard
- 1** with magnet
- 2** guided

⑨ Other versions

- B06** With calibration certificate
- Y01** Measured medium: always required, specify in plain text: Medium, Measuring range, Device range; Density; Viscosity, Device; Operating temperature, Operating pressure
- Y04** Silicone-free version
- Y99** Special version: specify in plain text

7 Measuring ranges for liquids

Standard measuring range for liquids ($\rho=1 \text{ kg/l}$, Viskosität $1\text{mPa}\cdot\text{s}$)

Connection		Measuring cone	Dynamic	Maximum measuring range (for the selected float)				Pressure loss float	
PVC Adhesive bushing [mm]	Female thread			Stainless steel with magnet	PVC/PVDF weighted	PVC/PVDF with magnet weighted	Stainless steel	Aluminium	
				l/h	l/h	l/h	l/h	mbar	mbar
20	(G $\frac{1}{4}$),	C40	1:10	40	40	20	20	10	4
	(G $\frac{3}{8}$),	C65	1:10	65	60	35	35	10	4
	G $\frac{1}{2}$	C100	1:10	100	90	55	55	10	4
		C160	1:10	160	160	100	90	12	5
		C250	1:10	250	240	140	140	12	5
32	(G $\frac{1}{2}$),	D400	1:10	400	400	300	250	17	7
	(G $\frac{3}{4}$),	D650	1:10	650	650	500	450	17	7
	G1	D1000	1:10	1000	1000	750	650	17	7
		D1600	1:10	1600	1600	1250	1000	20	7

(connections in brackets are non Standard)

8 Measuring ranges for air

Measuring range for air ($p_{abs}=1,013 \text{ bar}$, at $T=0^\circ\text{C}$, $\rho=1,293 \text{ kg/m}^3$, $\nu=0,0181 \text{ mPa}\cdot\text{s}$)

Connection		Measuring cone	Dynamic	Maximum measuring range (for the selected float)			Pressure loss float mbar
PVC adhesive bushing [mm]	female thread			Aluminium l/h	PVC/PVDF		
		not weighted l/h	with magnet l/h				
20	(G $\frac{1}{4}$), (G $\frac{3}{8}$), G $\frac{1}{2}$	C40	1:10	700	450	800	4
		C65	1:10	1200	700	1300	4
		C100	1:10	1800	1000	2000	4
		C160	1:10	2800	1800	3200	5
		C250	1:10	4000	3000	5000	5
32	(G $\frac{1}{2}$), (G $\frac{3}{4}$), G1	D400	1:10	7000	5000	6300	7
		D650	1:10	12000	8000	10000	7
		D1000	1:10	17000	12000	16000	7
		D1600	1:10	25000	20000	25000	7

(connections in brackets are not standard)

9 Technical Data

Input

Flow	Vertically upwards
Pressure limit	max. 10 bar

Application conditions

Environmental conditions (temperature limits)

Measuring cone made of Trogamide	max. 60 °C (for water 50 °C)
Pressure- and temperature limits	Measuring cone made of Trogamide: -10 bis +60 °C P _e [bar] 10,0 (for water only up to 50 °C)
Connection parts	see table 9.1

Measuring accuracy

For liquids	class 4 (acc. VDE/VDI 3513, sheet 2)
For gases	class 4 (acc. VDE/VDI 3513, sheet 2)

Measuring range

For liquids	4 l/h ... 1600 l/h
For gases	70 l/h ... 25 m ³ /h

Measuring units

Up to measuring cone D1600	l/h
----------------------------	-----

Construction design

Connection	PVC-adhesive bushing, female thread
------------	-------------------------------------

Material

Measuring cone	Polyamid (Trogamide)
----------------	----------------------

Connection

- union nut	PVC
- inlay part	PVC, cast iron, steel, stainless steel (1.4571/1.4404)
Float	Stainless steel (1.4571/1.4404), PVC, Aluminium, PVDF
Gasket	NBR (Perbunan), FKM (Viton®), EPDM
Stopper	Polysulfone

9.1 Pressure and temperature limits

Connection parts PVC DIN 8062		
Fluid	T(°C)	P _e [bar(psi)]
water and non-aggressive liquids	20	10,0
	40	10,0
	60	2,5
aggressive media	20	10,0
	40	4,0
	60	1,0

P_e = eff. pressure = overpressure

9.2 Dimensions

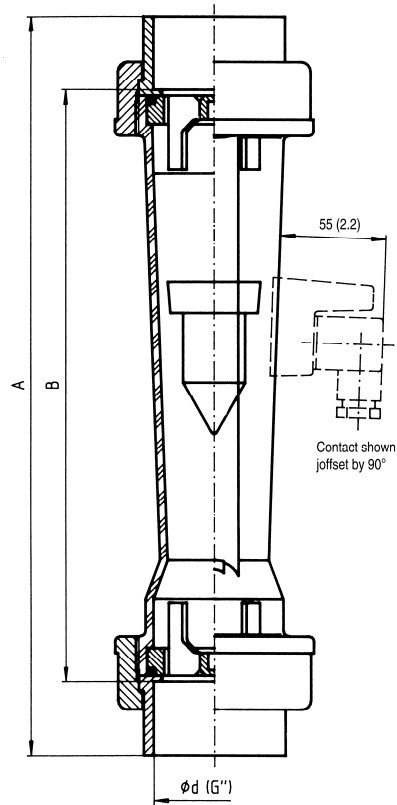

Fig. 4 FVA Troglux short version, dimensions in mm

Connection		Dimension A [mm]			Built in length B [mm]	Weight [kg] (Adhesive bushing)
Adhesive bushing (mm)	Female thread Sleeve	Adhesive bushing	Female thread Sleeve			
		PVC	Cast iron	PVC/PVDF/ Stainless steel		
20	G 1/2; NPT 1/2"	211 ± 4mm	216 ± 4mm	231 ± 4mm	171	0,15
32	G 1; NPT 1"	256 ± 4mm	258 ± 4mm	258 ± 4mm	206	0,35

10 Contacts

The bistable contact K18 is intended for signaling of limit values and for controlling purposes.

Special features

- bistable function
- high vibration resistance
- no interaction between contacts
- low cost plastic version
- easy to use electrical connection

Mode of operation

A bistable reed contact consists of a spring contact which is covered by a glass tube filled with inert gas. It is operated by a magnetic field. This magnetic field is generated by a permanent magnet inside the float of a MECON flowmeter.

There are two versions available:

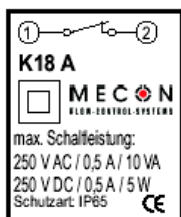

Fig.5 Contact K 18 A

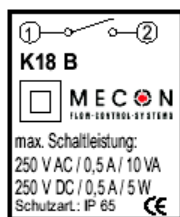

Fig.6 Contact K 18 B

K 18 A: contact closes on falling below the limit

K 18 B: contact closes on exceeding the limit

Electrical loadability

The spring contacts of the K18 are sensitive to current overload (max. 500 mA). A high current could lead to a welding effect and this will damage the contact blades – this specifically applies to inductive loads e.g. relais (high self-induction).

Protective circuits

At great cable lengths (cable capacity) it is recommended to connect a protective resistor in series to contact K18 A(B) for current limitation.

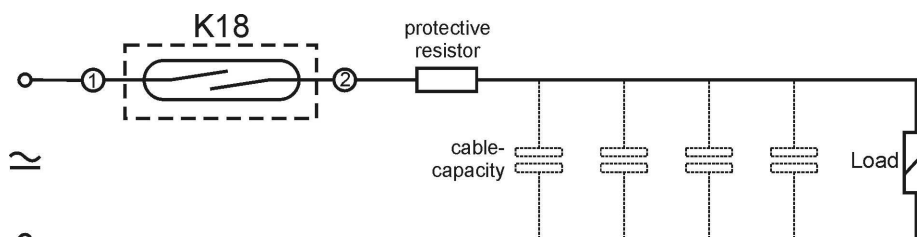

Fig.7 Protective circuit for current limitation

When using a DC power supply in combination with an inductive load it is recommended to connect a diode in parallel to the load.

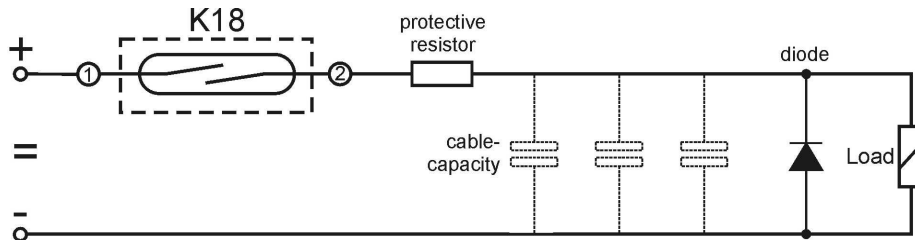

Fig.8 Protective circuit for inductive loads and DC power supply

Technical data

Contact material	Rhodium (with inert gas)
max. switching capacity	5 W / 10 VA
Max. switching voltage	250 V DC/AC
Contact resistance	0,1 Ω
Isolation resistance	10 ¹¹ Ω
Contact closing time	2 ms
Contact opening time	0,07 ms
Frequency of operation	2000 Hz
Duration of bounce	0,5 ms
Temperature range	-40 °C to +80 °C
Material of housing	Plastics
Electrical connection	Rectangular connector acc. to DIN EN 175301-803 (previously DIN 43 650)
Protection class	IP 65
Max. starting current (peek)	0,5 A
Max. switching current	230 V DC : 21 mA
	115 V DC : 43 mA
	24 V DC : 0,2 A
	10 V DC : 0,5 A



Warning !

Observe in any case the max. switching capacity and the max. starting current – otherwise a welding effect will damage the contact blades.

Installation of the connection cable to the connector:

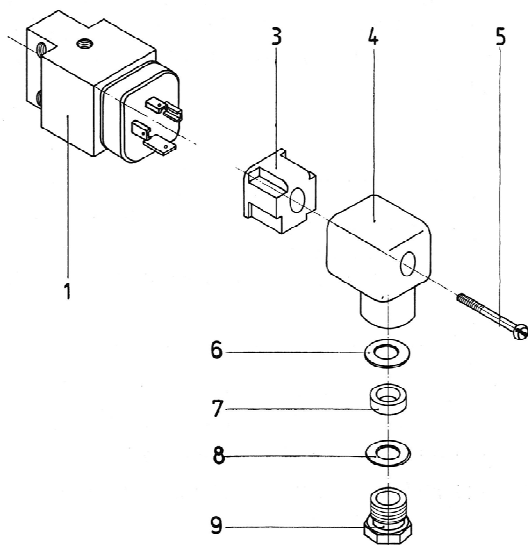

1. Remove the cable gland (9) and take out the gasket kit (8, 7, 6).
2. Remove the locking screw (5) and pull of the housing (4) from the insert connector (3).
3. Insert the connection cable through the cable gland (9), the gasket kit (6, 7, 8) and the housing.
4. Connect the wires to terminal 1 and 2 of the insert connector.
5. Assemble the rectangular connector in reverse order as described above. Please note, that the cable outlet can be varied by rotating the insert connector (4) through 90°.

Fig. 9 Explosion drawing contact K 18

Commissioning:

When commissioning the contact K18 we recommend to ensure the correct position of the bistable contact by moving the float along the K18 in flow direction.

Mecon GmbH

Röntgenstraße 105
D 50169 Kerpen

Tel.: +49 (0)2237 600 06 - 0
Fax.: +49 (0)2237 600 06 - 20
Email: customerservice@mecon.de

www.mecon.de

