

mag-flux® HTL

Portable hydrant tester for measuring flow, pressure, temperature* and turbidity*

*optional

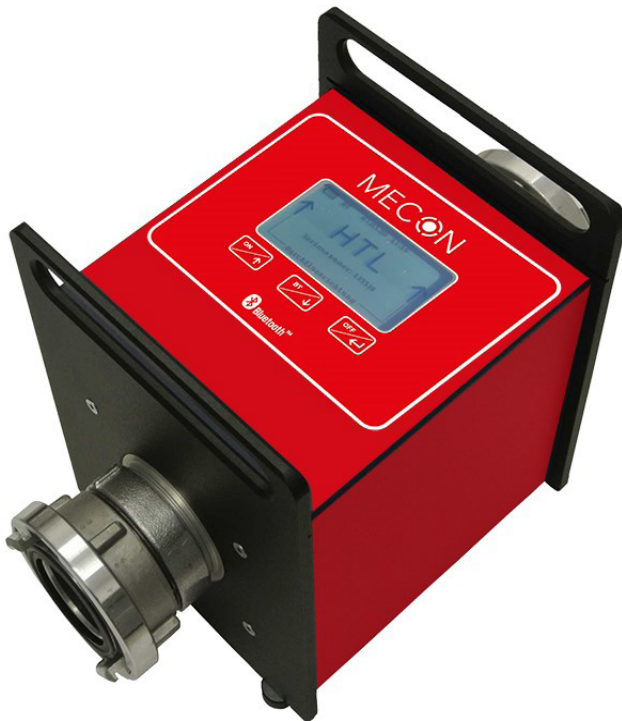

IMPRINT

All rights reserved. Any reproduction or usage without written authorisation of MECON GmbH - even partial content - is strictly prohibited.

Subject to change without notice.

Copyright 2023 by MECON GmbH - Roentgenstr. 105 - 50169 Kerpen - Germany

Content

1	SAFETY INSTRUCTIONS.....	6
1.1	Intended use.....	6
1.2	Certifications	7
1.3	Manufacturer's safety instructions	7
2	DEVICE DESCRIPTION.....	9
2.1	Scope of delivery	9
2.2	Nameplate	10
3	INSTALLATION AND MODE OF OPERATION	11
3.1	System design.....	11
3.2	Installation notes	11
3.3	Installation instructions	12
3.4	Operating elements - functional overview	12
3.5	Settings.....	15
3.5.1	Recording interval	15
3.5.2	Sensor attenuation	16
3.5.3	Date/ Time.....	17
3.5.5	Change password.....	17
3.5.4	Backlight time	17
3.5.6	Standby.....	18
3.5.7	Language.....	18
3.5.8	Software version.....	18
3.6	Select units	19
4	START-UP.....	20
4.1	Start measuring	20
4.2	Record the measurement	21
4.3	Record measurement (optionally with turbidity measurement)	22
4.4	Selecting Bluetooth mode	23
4.5	Data management.....	24
4.6	Read data	24
4.7	Critical battery status.....	25
5	TECHNICAL DATA.....	26
5.1	Flow meter.....	26
5.2	Pressure sensor	26

5.3	Temperature sensor	26
5.4	Turbidity sensor (seperate device).....	27
5.5	Medium conditions.....	27
5.7	Design / material	27
5.6	Power supply	27
5.8	Dimensions and weights.....	28
6	EQUIPMENT.....	29
6.1	Mobile App.....	29
7	SERVICE.....	29
7.1	Storage	29
7.2	Maintenance	29
7.3	Returning the device to the manufacturer	30
7.4	Disposal	30

1 SAFETY INSTRUCTIONS

1.1 Intended use

Magnetic-inductive flow meters (MID) are precision measuring instruments that are suitable for the linear flow measurement of almost all electrically conductive liquids. Due to the magnetic field, they can be used for flow velocities up to 12 m/s (39.4 ft/s) and for a minimum conductivity of 50 $\mu\text{S}/\text{cm}$ with a synchronised DC field.

The complete measuring system consists of a battery-powered flow meter and pressure transmitter.

This documentation contains the information required for the intended use of the product described therein. It is addressed to qualified personnel. Such personnel must have read and understood these operating instructions and follow the instructions within them!



Warning!

The operator of these measuring devices is solely responsible for the suitability, intended use and corrosion resistance of the selected materials. Particular effort must be made to ensure that the materials selected for the wetted parts of the flow meter are suitable for the process media to be measured.

The meter must not be exposed to external loads.

1.2 Certifications

CE marking



By affixing the CE mark, the manufacturer certifies that the mag-flux HTL mobile hydrant tester is approved according to the following guidelines:

- » 2014/30/EU (EMC)
- » 2014/53/EU (RED)

1.3 Manufacturer's safety instructions

The manufacturer is not liable for damages of any kind caused by the use of the device, including, but not limited to, direct, indirect, incidental, punitive and consequential damages.

For every product purchased from the manufacturer, the warranty only applies when used according to the relevant product documentation and the valid terms and conditions.

The manufacturer reserves the right to revise the content of the documents, including this disclaimer, without notice, and is not liable in any way for the possible consequences of such changes.

The responsibility for ensuring that the flow meter is suitable for the particular application rests solely with the operator. MECON GmbH assumes no liability for any damage caused by improper use, replacement parts, electrical or mechanical external influences, over-voltage or lightning. Under such circumstances the warranty lapses. Likewise, no liability whatsoever is accepted for any resulting consequential damages.

In case of a complaint the rejected components must be cleaned of hazardous substances and to be returned to the manufacturer unless otherwise agreed.

To prevent injury to the user or damage to the unit, it is required that you read these operating instructions carefully before starting to use the device.

These instructions are intended to cover the correct installation, operation and maintenance of the equipment.

Special designs for special applications and custom models are not covered by this documentation.

2 DEVICE DESCRIPTION

2.1 Scope of delivery



①



②



- ① Hydrant tester
- ② Power adapter
- ③ Operating instructions
- ④ Calibration certificate

③



④



Fig. 1 Scope of delivery

2.2 Nameplate

Nameplate mag-flux HTL



		Röntgenstr. 105 50169 Kerpen	
mag-flux HTL			
① Order code:	HTL080	①	Item number
② Options:	TE	②	Options
③ Serial no.:	2022123456	③	Serial number
④ Connection:	Storz B	④	Process connection
⑤ Protection:	IP 54	⑤	Protection class
⑥ Supply:	NiMH Batt, Inside 	⑥	Power supply
⑦ Flow range:	0 - 217,2 m ³ /h	⑦	Flow range
Op. pressure max.:	+ 25 bar	⑧	Operating pressure (-1 ... 16 bar) 25 bar on request
⑧ Op. pressure min.:	-1 bar	⑧	
⑨ Op. temp. max.:	+ 40 °C	⑨	Max. operating temperature
Made in Germany		www.mecon.de	

Fig. 2 Nameplate mag-flux HTL

Downloading this document from the homepage of www.mecon.de and printing it out is permitted for use with associated devices. No part of this manual may be reproduced or transmitted by electronic or mechanical means, photocopying or other means of recording, or by any other means, without the prior written consent of MECON GmbH.

Great care has been taken in the development and preparation of this manual. Nevertheless, mistakes cannot be fully eliminated.

MECON GmbH offers no warranty, express or implied, as to its suitability for any purpose other than that described in this manual.

We reserve the right to change technical data as a result of technological progress. The latest information on this product can be found on the internet at www.mecon.de. You can also contact our sales department via e-mail at info@mecon.de.

3 INSTALLATION AND MODE OF OPERATION

The operating instructions are to be read in their entirety before installation and commissioning. Installation and repair may only be carried out by trained personnel! The hydrant tester "mag-flux HTL" described in these operating instructions may only be used for measuring the volume flow and pressure of electrically conductive liquids!

The principle of flow measurement is based on Faraday's Law of Electromagnetic Induction, where the sensor converts the flow into a voltage proportional to the flow rate.

The pressure-sensitive element is a piezoresistive silicon chip with high sensitivity. It is protected from environmental influences by a stainless steel housing.

3.1 System design

The meter consists of a flow sensor, a transducer and a pressure sensor. The flow sensor is used to measure liquid media. The transducer generates the coil current required for the magnetic field and creates the conditions to apply the induced voltage to the electrodes.

In the piezoresistive pressure sensor, measurements are made by the variable mobility of the electrons in the crystalline structure, which has an influence on the resistivity. This is caused by mechanical stress on the encapsulated sensor.



The nickel-metal-hydride high performance batteries used have a low self-discharge. For this reason it is advisable that if the hydrant tester is not in operation for a long time, it is charged regularly (at least once every four weeks).

3.2 Installation notes

Information!

All instruments are carefully checked for proper functionality before shipment. On receipt, immediately check the outer packing carefully for damage or signs of improper handling.

Report any damage to the carrier and your local sales staff. In such cases, a description of the damage, the type and the serial number of the device should be given.

Unpack the unit carefully to avoid damage.

Check the completeness of the delivery against the packing list. Check the nameplate to ensure that the delivered flow meter meets your order.

3.3 Installation instructions

In general, the measuring principle is independent of the flow profile.

The ideal installation location is a pipe with a sufficiently straight section in front of and behind the measuring point. An inlet section of 5 x nominal width and an outlet section of min. 2 x nominal width is recommended, provided that no standing vortices can reach into the zone where the measured value is determined (e.g. after elbows, with tangential inclusion or with a half-opened gate in front of the sensor). In such circumstances, measures should be taken to normalise the flow profile.

To ensure trouble-free operation, avoid any direct magnetic fields outside the unit.

3.4 Operating elements - functional overview



ON button

- » **Switching on the hydrant tester**
- » **Arrow upwards**

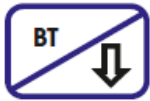

BT button

- » **Turn Bluetooth on / off**
- » **Arrow down**



OFF / Enter button

- » **Confirm the selection**
- » **Press and hold cancels the selected function**
- » **Press and hold in start mode results in the device switching off**

Pairing code for the 1st Bluetooth connection: -1234-

To turn on the hydrant tester press the "ON" button. The start-up screen will appear.

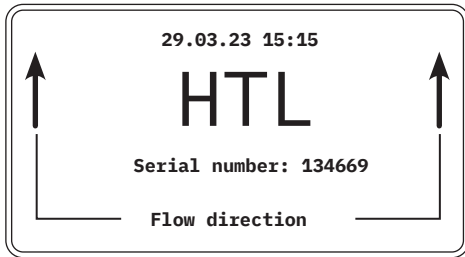

For a clear representation of the functionalities, the menu structure will now be shown schematically as follows:

Main menu

- Start measuring
- Settings
- Turbidity
- Bluetooth Mode
- Units
- Data Management
- Exit

Start measuring

- Record the measurement
- Without saving measurement
- Exit

Settings

- Recording interval
- Sensor attenuation
- Set date
- Set time
- Lighting time
- Change password
- Standby
- Language
- Software version
- Exit

Turbidity

- Turbidity enabled
- Exit

Bluetooth Mode

Bluetooth Mode

Exit

Units

Pressure

Flow

Temperature

Exit

Data Management

Delete last dataset

Delete all datasets

Exit

You will be taken to the main menu by pressing the "ON" button again.

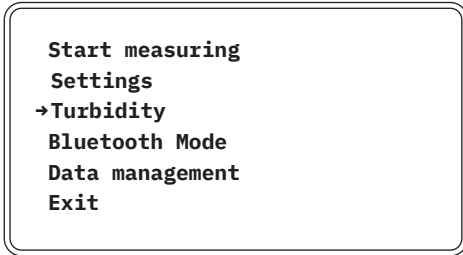

If the device is equipped with a turbidity measurement (seperat sensor necessary) , before starting the measurement it should be determined whether this value should be documented or not. If these data are required for measurement, they must be present.

3.5 Settings

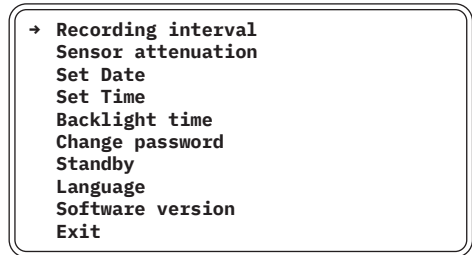
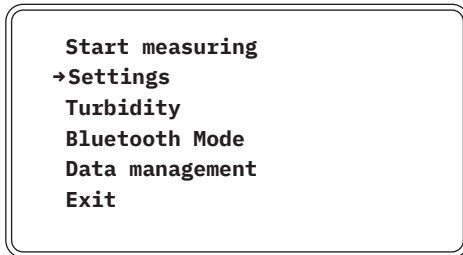

Using the "ON" button and the "BT" button, select "Settings" and confirm with the "OFF / Enter" button.

3.5.1 Recording interval

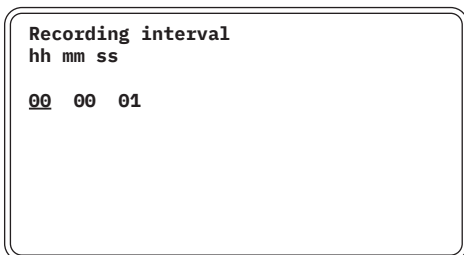

The arrow buttons ("ON" button or "BT" button) can be used to set the parameter marked by the underscore. This action is confirmed by pressing the "OFF / Enter" button (hours: minutes: seconds).

A storage interval of 1 second is set in the as-delivered condition.

3.5.2 Sensor attenuation

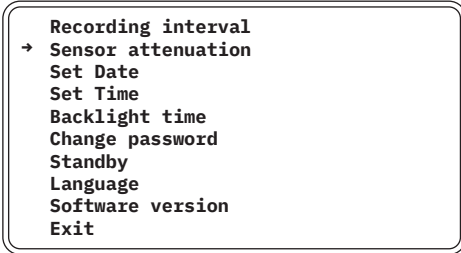

By selecting "Sensor attenuation", the attenuation for pressure and flow can be set. By confirming the menu item „Sensor attenuation” via "OFF / Enter” button the "Sensor attenuation" menu appears.

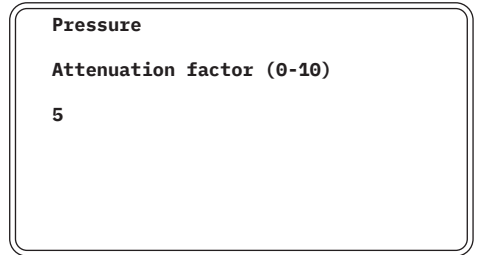
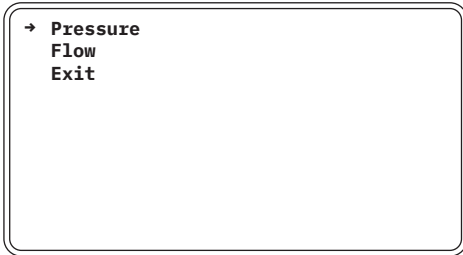

In the respective submenus by selecting "OFF / Enter" button it is possible to set the damping factor manually. The value "0" stands for the lowest and the value "10" for the highest attenuation.

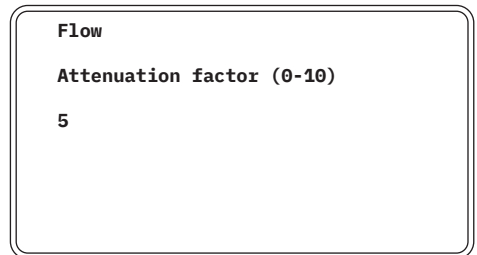
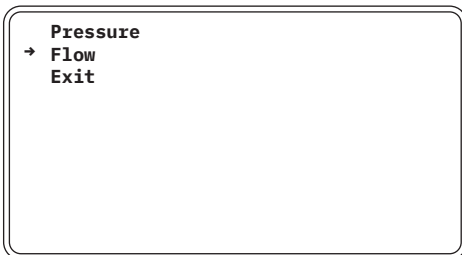

By pressing the arrow keys ("ON" button or "BT" button) you can select between the values. A desired value is confirmed with of the "OFF / Enter" button.

3.5.3 Date/ Time

Set date

29.03.21

Factory set already!

Set time

15:09:19

Factory set already!

3.5.4 Backlight time

Backlight time
From 0 to 240 seconds

60

The lighting time of the LCD display can be set in seconds.

0 = steady light

The duration can be set individually in seconds using the arrow buttons and by confirming with the "OFF / Enter" button.

Factory set to 60 seconds!

3.5.5 Change password

Enable password?

No

When this menu item is called up, the adjacent screen will appear. To protect the operation of the device with a password, enter a four-digit number. After confirming with the "OFF / Enter" button the password protection is active.

"Password: 0000" appears. By confirming with the "OFF / Enter" button you can now access the menu (only if this parameter was activated in the menu item "Change password").

3.5.6 Standby

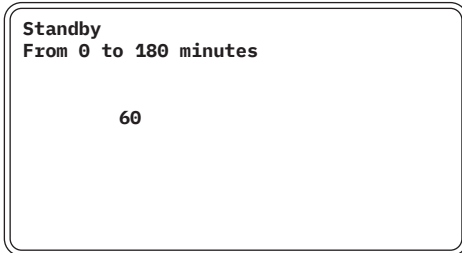

The device does not turn off automatically after a measurement is completed. A time period (in minutes) can be entered here, after which the device switches itself off automatically.

3.5.7 Language

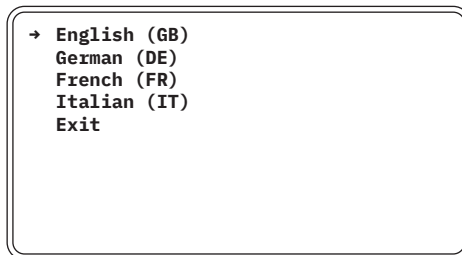

Individually, another language can be set in this menu item.

3.5.8 Software version

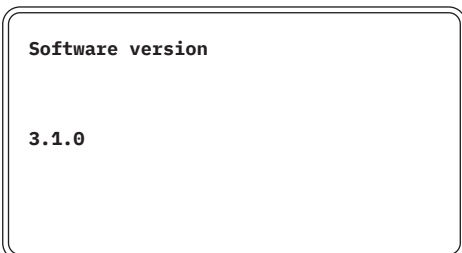

The current software version is displayed here for service purposes.

3.6 Select units

Use the arrow buttons ("ON" button or "BT" button) to select "Units" with the "OFF / Enter" Button.

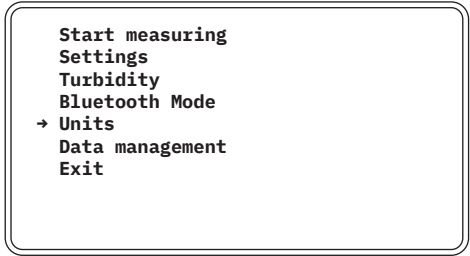

Selecting the measured value takes you to the selection of possible measuring units. Press the "OFF / Enter" button to save the selected unit. The current unit is displayed under "selected". After selecting a unit, or by selecting "Exit", you return to the previous menu.

Selection of the unit for pressure:

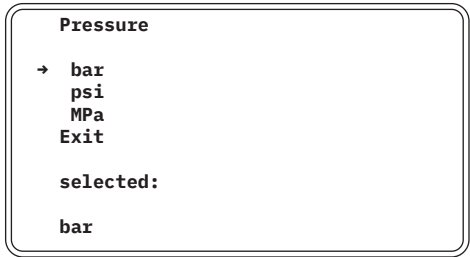
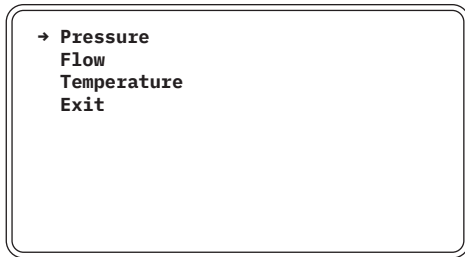

Selection of the unit for flow:

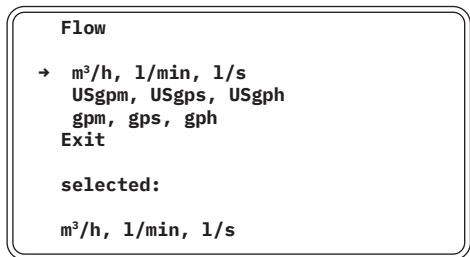
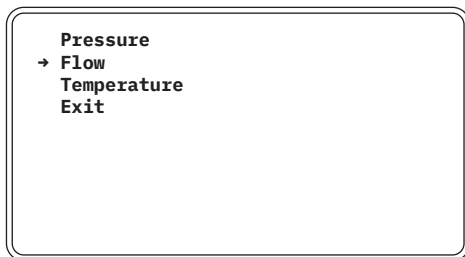

The selected units for the flow rate can be changed during the measurement by pressing the "ON" button.

Selection of the unit for temperature:

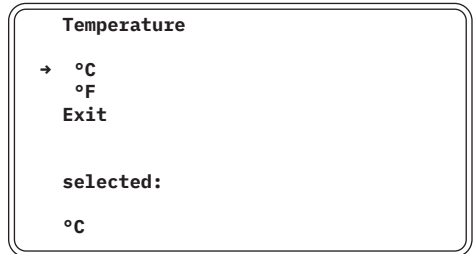
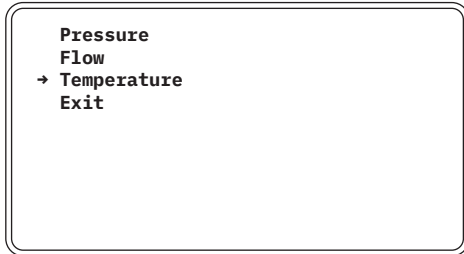

The selected units are saved and only need to be selected once.

4 START-UP

4.1 Start measuring

The device is switched on with the "ON" button. Press the "ON" button again to return to the main menu.

The next menu item is selected using the arrow buttons ("ON" button or "/" BT" button)

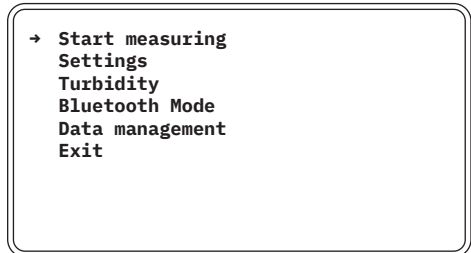

After that, the following dialogue box appears:

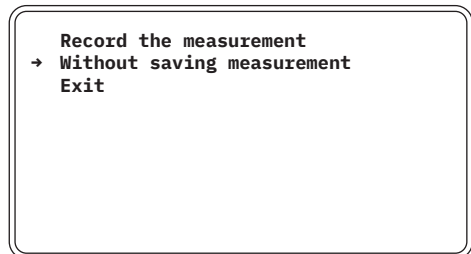

It can be selected note the arrow buttons ("ON" button or "BT" button) you can select whether a measurement is made with the measuring point and the associated data being stored on the device or a measurement without storage of the data.

4.2 Record the measurement

When measuring with data storage in the device (and the possibility of subsequent further processing by means of the optionally available evaluation software, Wasserkarte.info), the following selection must be made:

→ **Record the measurement**
Without saving measurement
Exit

The following display appears for the alphanumeric description of the measuring point:

Description

A

The underscored letter can now be replaced by pressing the arrow buttons ("ON / BT" button), either with a different letter, number or special character. The following contents can be displayed (maximum 15 characters):

Letters: A ... Z / a ... z

Numbers: 0 ... 9

Special characters: _ : () + -

Please confirm the change with the "OFF / Enter" button.

This allows the measured values to be assigned to a measuring point description.

By holding the "OFF / Enter" button longer, the following appears:

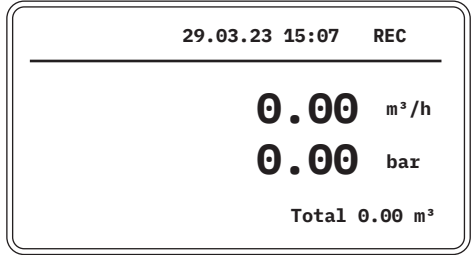

From now on, all measured values will be stored - the information "REC" for record will appear in the display at the top right. In addition to the current measured values of flow rate and absolute pressure, the total flow rate is displayed in the lower right corner of the display.

Note: To display in l/min or l/s, the "ON" button must be pressed.

If you want to stop the measurement, press and hold the "OFF / Enter" button and then the following appears:

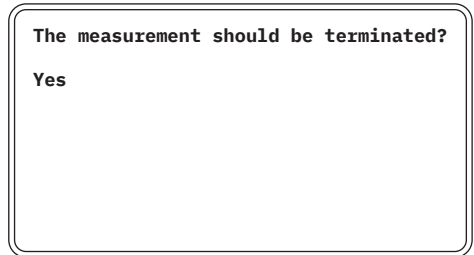

Afterwards, confirm by pressing the "OFF / Enter" button. The measurement is now complete and the start screen appears.

4.3 Record measurement (optionally with turbidity measurement)

To measure with turbidity, please select the main menu item "Turbidity" and press the "OFF / Enter" button.

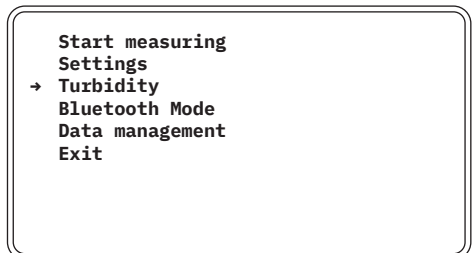

The following contents then appear on the display

Turbidity
Turbidity: enabled
 → **Exit**

To activate the turbidity, press the button "OFF / ENTER" in the menu item "Turbidity".

Afterwards, the menu item "Exit" takes you back to the main menu.

Turbidity
Turbidity: Disabled
 → **Exit**

After leaving the menu by selecting the "Back" field, the measurement can be carried out as described in 4.1 and 4.2.

4.4 Selecting Bluetooth mode

By pressing the menu item "Bluetooth-Mode", you can choose between the variants BT (Bluetooth) and BLE (Bluetooth Low Energy).

The following settings are recommended depending on the operating system of the Wasserkarte.info app:

BT - Android
 BLE - iOS

You can then return to the main menu via the menu item "Back".

Bluetooth Mode
 → **Bluetooth Mode: BT**
Exit

Bluetooth Mode
 → **Bluetooth Mode: BLE**
Exit

4.5 Data management

After all series of measurements have been read out and saved in the PC software, the memory space used for this can be released again. All measured values are retained in the memory, even when the battery is discharged.

The selection of the corresponding function is carried out with the arrow buttons ("ON" button or "BT" button) the confirmation by means of the "OFF / Enter" button.

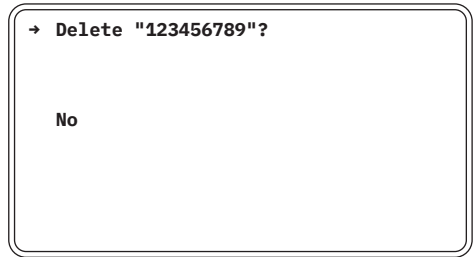
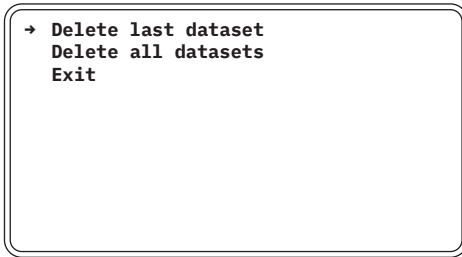

4.6 Read data

In order to establish a Bluetooth connection between a Bluetooth enable and the hydrant tester, in addition to activating the appropriate function on the mobile device, the mag-flux HTL must be switched on with the "ON" button. When the Bluetooth connection is activated for the first time, the pairing code -1234- must be entered on the mobile device (see also 3.4). Afterwards you have to press the "BT button". The following screen appears:

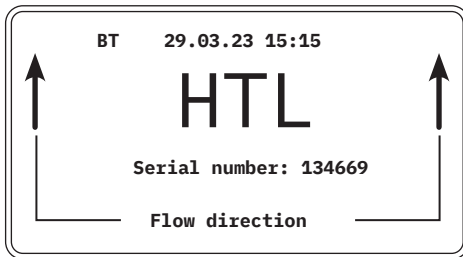

As soon as a Bluetooth connection is established between the hydrant tester and the mobile device, the Wasserkarte-info APP has access to the mag-flux HTL.

After a successful data transmission, the Bluetooth module should be switched off again by pressing the "BT" button.

4.7 Critical battery status

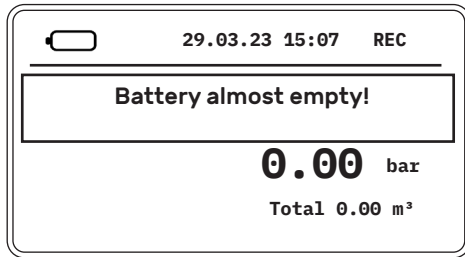

When the battery level is low, an additional visual message is shown in the display to protect the battery and prevent deep discharge (see figure). The device can now be switched off by briefly pressing the "OFF / Enter" button.

As soon as the message occurs during a measurement, the measuring units can still be changed with the "ON" button. Measurements in progress are saved up to this point, provided they were started in advance with "Record measurement".

In addition, the battery symbol flashes in the display. The device should be connected to a power supply as soon as possible. (see also the note under 3.1). The device switches off automatically to protect the batteries when the battery level is too low.

5 TECHNICAL DATA

5.1 Flow meter

Measuring principle	Synchronised DC field
Input » Process connection / nominal diameter	DN 50 ... DN 150 Storz C ... Storz F
Measuring accuracy » Measurement error » Repeatability accuracy	± 0.5 % of the measured value from 1 m/s ... 12 m/s ± 0.15 % of the measured value from 0.5 m/s ... 10 m/s
Mounting position » Inlet section » Outlet section	5 x nominal diameter 2 x nominal diameter
Fluid temperature	34 °F ... 104 °F (1 °C ... 40 °C)
Ambient temperature	34 °F ... 122 °F (1 °C ... 50 °C)
Type of protection	IP 54 (dust protected, splash protection)

5.2 Pressure sensor

Pressure limits	14 ... 232 psi
Accuracy	0.25 % FS
Temperature coefficient » Zero point max. » Sensitivity type	32 °F ... 122 °F (0 °C ... 50 °C) 0.0125 mV/°C 0.01 %/°C
Influence of base pressure	0.01 %/°C
Compensated area	14 °F ... 176 °F (-10 °C ... 80 °C)

5.3 Temperature sensor

Type	PT 1000 class B, DIN EN 60751
Accuracy	± 1 % FS

5.4 Turbidity sensor (seperate device)

Type	ISO 7027 compliant 90° scattered light and 180° transmitted light measurement pre-calibrated with formazin in FNU units
Accuracy	±0.5 % of measured value ±1.0 % of full scale value
Fluid temperature	41 °F ... 140 °F (5 °C ... 60 °C)
Measurement range	0.1 ... 100 FNU

5.5 Medium conditions

Medium, state of aggregation	Water, liquid
Minimum conductivity	>50 µS/cm

5.7 Design / material

Execution	Compact flow meter with built-in pressure sensor
Weight	see Tab.1
Display	5 inch LCD display, backlit display (240 x 128 pixels)
Flow rate limits	0.25 ... 12 m/s
Housing material	Aluminium
Sensor materials	
» Measuring tube	PVC
» Coil space	PVC
» Measuring tube lining	PVC
» Electrode material	Stainless steel
Corrosion protection class	C2 (low polluted atmosphere, dry climate)

5.6 Power supply

Power supply	2 integrated rechargeable battery packs (NiMH) each 7.2 V
Operating time	up to 24 hours
Charging time	approx. 4 hours

5.8 Dimensions and weights

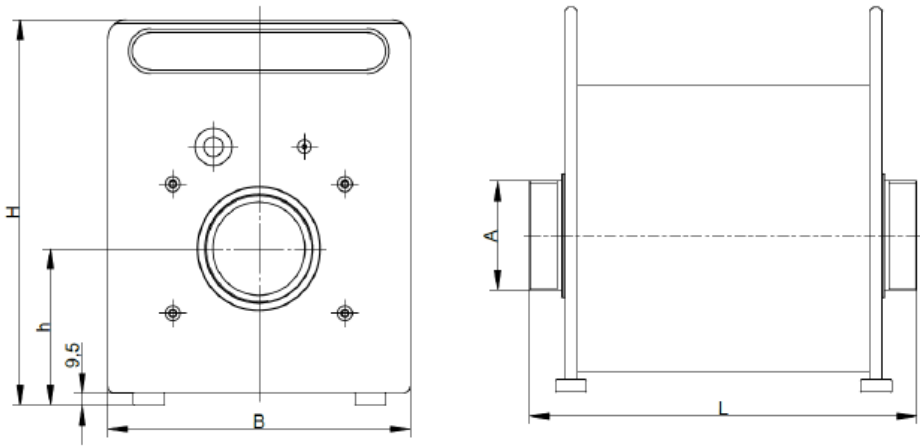

Fig. 3: Dimension housing mag-flux HTL

Nominal diameter		L (mm)	W (mm)	H (mm)	Weight (kg)
DN 50	Storz C	310	246	310	14.5
DN 65	Storz B	310	246	310	14.5
DN 80	Storz B	310	246	310	14.8
DN 100	Storz A	365	272	337	19.5
DN 150	Storz F	390	336	400	32.0

Tab. 1: Dimensions and weights mag-flux HTL

6 EQUIPMENT

6.1 Mobile App

In addition to the easy-to-read display, the measuring process can be controlled via the field-tested app from the company wasserkarte.info. All measurement data for pressure, flow rate, temperature and turbidity are transmitted live via Bluetooth from the hydrant tester to the app. The measurement protocols as well as diagrams are displayed directly as a preview. The holistic solution approach for hydrant maintenance from documentation, planning, localisation, performance to maintenance.

<http://wasserkarte.info/en/hydrant-measurement>

To the website:

<https://wasserkarte.info/en/hydrant-measurement/>



7 SERVICE

7.1 Storage

Store the emptied device in a dry and dust-free place. Keep away from direct heat and sunlight. Avoid external loads on the device. The permissible storage temperature is -4 °F ... 140 °F.

7.2 Maintenance

The hydrant tester "mag-flux HTL" is maintenance-free. It is recommended that the device be returned to the manufacturer for recalibration after two years, depending on the conditions of use (see point 7.3 Return of the device to the manufacturer). This will guarantee a long and trouble-free service life.

7.3 Returning the device to the manufacturer

Due to careful manufacturing processes and final checks on the device, the mag-flux HTL is expected to operate trouble-free, where both installation and operation are in accordance with these instructions

Should you nevertheless need to return a device to MECON GmbH please observe the following points:



Caution!

In order to protect the environment and safeguard the health and safety of our personnel, all devices sent to MECON GmbH for repair must be free of toxic and hazardous substances. This also applies to cavities in these devices. If necessary, the customer is kindly requested to neutralise or rinse these devices before returning them to MECON GmbH. The customer must confirm this by completing and sending in the returns form on the MECON GmbH website. This can be found at

» <https://www.meccon.de/en/maintenance-and-repair/>

7.4 Disposal



Caution!

Always comply with the regulations in your country when disposing of devices.



Electrical and electronic equipment must not be disposed of with household waste. As the owner of such equipment, you are required to deliver it to a separate municipal waste collection point (unsorted municipal waste).

Some of our products include batteries, some of which are rechargeable, which also must not be disposed of with household waste. Such batteries are marked with the crossed-out dustbin symbol under which the chemical symbol for classification as heavy metal containing harmful substances (Cd for cadmium, Hg for mercury or Pb for lead) is affixed. As a consumer, you are legally obliged to return used batteries. You can hand them in for professional disposal at public collection points or return them to us.



MECON GmbH
Roentgenstr. 105
50169 Kerpen
Germany

Tel.: +49 (0) 2237 600 06 - 0

E-mail: info@mecon.de

Web: www.mecon.de